

Doseur D12

contact@palamatic.fr
+33(0)2 99 86 06 22

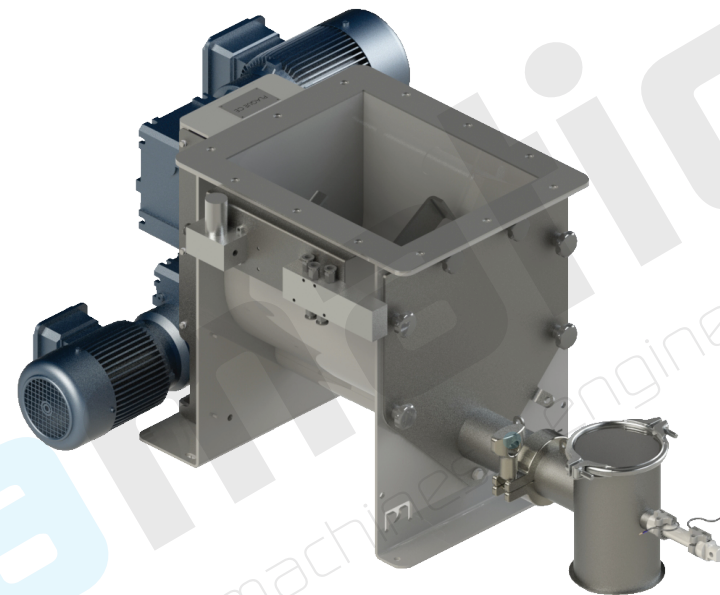
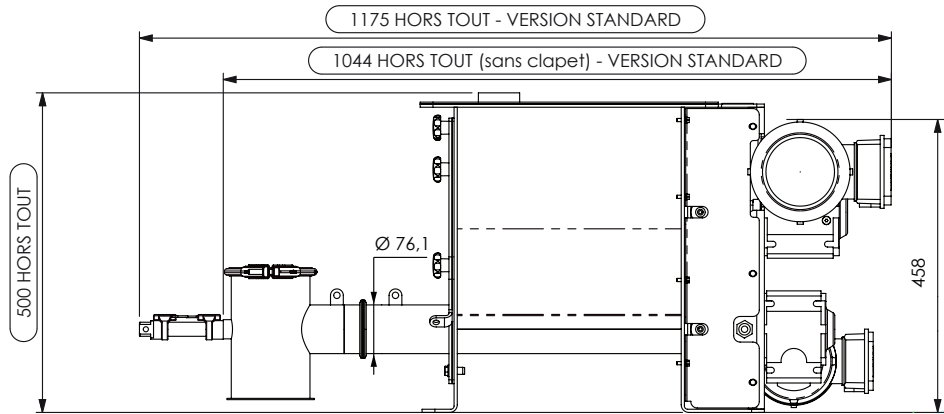

SANS VENTILATION FORCEE POUR
MOTEUR VIS DE DOSAGE

AVEC VENTILATION FORCEE POUR
MOTEUR VIS DE DOSAGE

